

AC iPurifier

Active Mains Purification

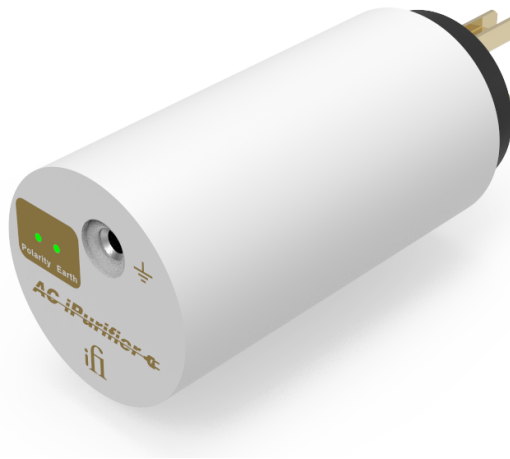

Part 1: Actively goes where no purifier has gone before

Mains is the fuel that powers an audio system. Whether it is clean or not has a material impact upon quality and the user's enjoyment of playback. iFi's latest 'power product', the AC iPurifier, is no ordinary mains purification commodity.

Technologically advanced, it is an ACTIVE not a passive product, so it goes above and beyond and cancels far more noise across the frequency range than passive devices.

It is effective against both:

- i. Common mode noise existing equally on both of the power pins, referenced to the earth pin.
- ii. Differential noise existing only between the two power pins – the net to earth is zero.

They are, in effect, flip sides of the same coin and are the bane of audio systems regardless of the type of power supply.

Nullifies noise others can't reach

Compared to other generic noise filters, the AC iPurifier is superior because it is ACTIVE as opposed to passive. This enables it to achieve a far more comprehensive termination of noise across the frequency spectrum. As noise exists across the frequency range, this clearly means the AC iPurifier is unparalleled when it comes to neutralizing noise.

This chart compares the AC iPurifier (green line) which is ACTIVE to generic mains filters (red line) which are typically passive.

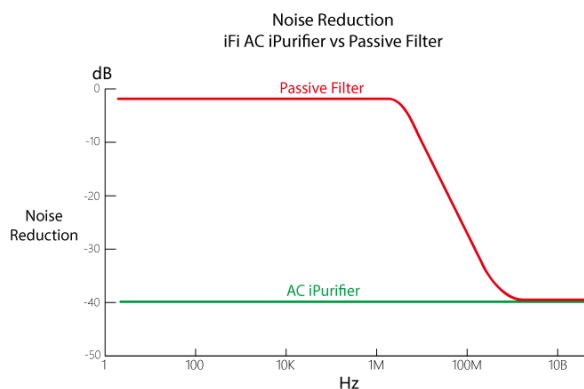

The effective noise reduction difference is as different as night and day.

- i. MUCH better at -40dB and...
- ii. Effective across the frequency range. Whereas the passive filters only in the very top-end of the frequency range.

Every audio system benefits from the AC iPurifier

The AC iPurifier is designed for use in ANY mains powered audio system and is very effective when added to modern audio systems that have an abundance of digital and analogue components. Typically these systems are powered from a plethora of mains plugs. All of these 'wall warts' can add their own unwanted noise issues and pollute the local mains supply. However, the design of the AC iPurifier is such that it is even more effective if several are used to 'contain' the same type of noisy sources.

Insert it into the AC mains wall outlet supplying the audio system OR insert into the mains extension block powering the audio system. Try both locations to determine which has the greatest impact on improving any noise issues.

The figure below shows the best position for using one, two, three or more AC iPurifiers at the same time.

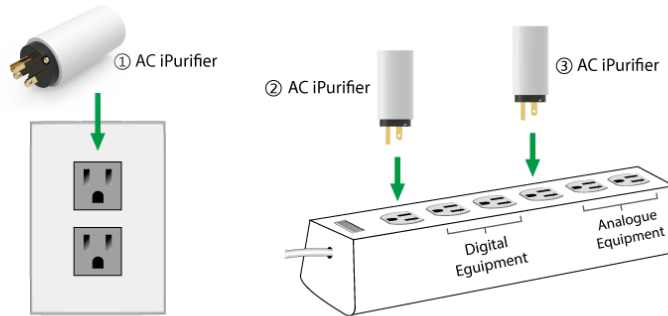

Bristling with serious Power Technology

Compared to similar AC power products, the AC iPurifier can boast the technological features below, making it far more comprehensive and effective than its rivals.

1. Purification	
1.1 Active Noise Cancellation (ANC)	Military technology – the most advanced active noise-cancellation available.
1.2 Wireless Noise Nullification	A complex circuit that significantly reduces power line noise without audible or visible side-effects caused by wireless sources
1.3 Audio Earth connection	A solid Ground/Earth with ground-loop prevention circuit built-in.
2. Diagnostics	
2.1 Ground/Earth connection diagnostic	Detects a missing Ground/Earth.
2.2 Polarity connection diagnostic	Detects a polarity fault.
3. System Protection	
3.1 Overvoltage Surge Protection	Auto-recovery.

Part 2: Mains noise. A real bane.

Power supply noise is the bane of every audio system. There are always multiple sources of noise and they come from two main sources – inside and outside.

External noise is all around

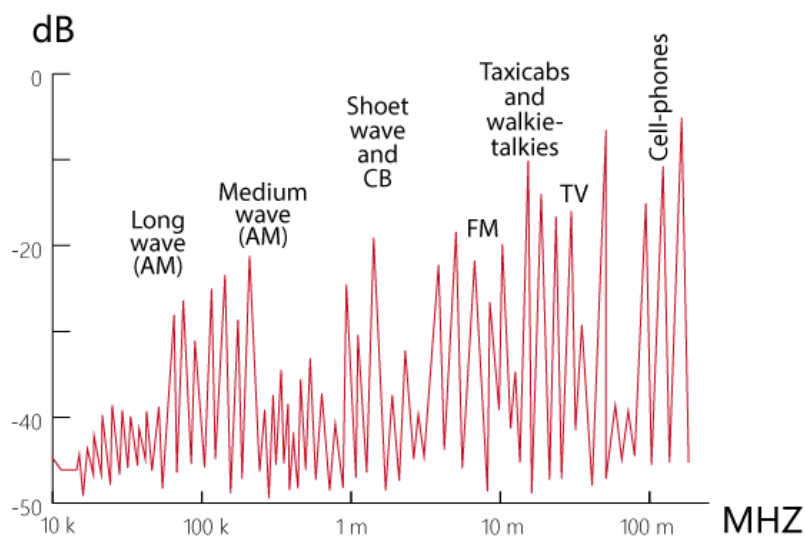

This chart shows that noise is anywhere and everywhere and some of it inevitably ends up in the mains that supplies the audio system. Most of the sources, we can do little about as they are found in everyday life such as radios or mobile phones.

These sources being wireless in nature, mean that it is very difficult to deal with them at the source. Hence, we need to address the symptom.

The next chart shows the ‘local’ noise sources found in and around an audio system.

Local noise comes from hi-fi components

These sources of noise are found in hi-fi systems and come from three main sources:

- i. AC mains power supplies
- ii. Switch-Mode Power Supplies
- iii. Digital circuitry.

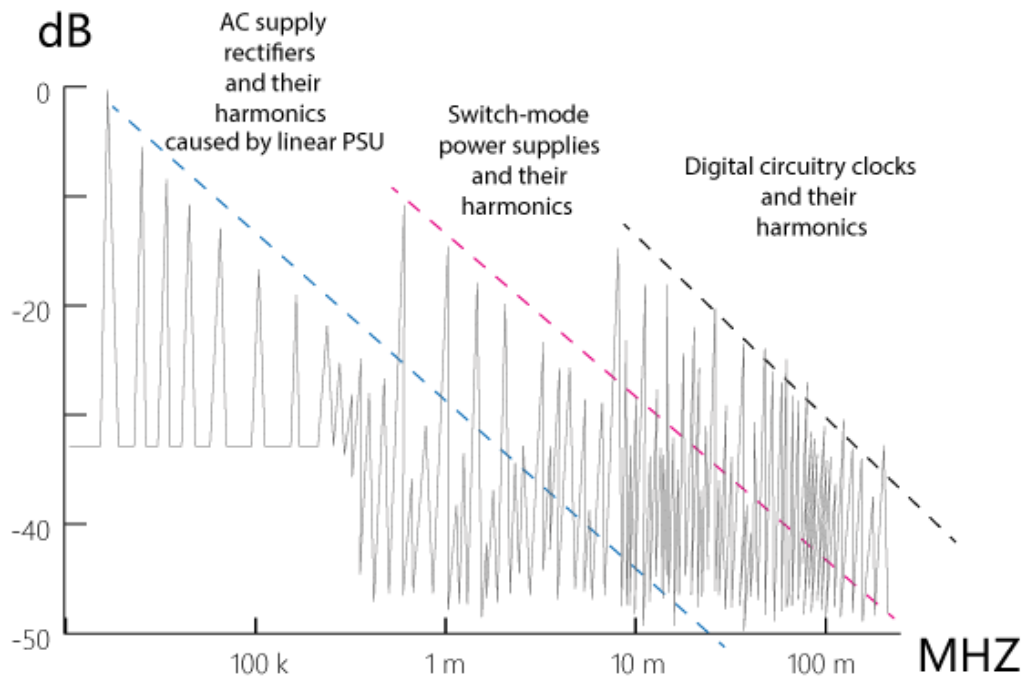

From left to right:

The first set of noise sources (10k > 10MHz) relate to AC supply rectifiers and their harmonics caused by Linear Power Supplies (LPS). Yes, they make a noise!

The second set of noise sources (67k > 200 MHz) is caused by Switch-Mode Power Supplies (SMPS). By comparison, these harmonics run in the higher frequencies.

The third set of noise sources (8 MHz > 500 MHz) is caused by digital circuitry, clocks and their harmonics. And this type of noise exists in the most upper frequencies.

You can see from the chart that the concentration of noise is from 30kHz upwards (the lower the dB, the less influential is the noise).

LPS vs SMPS

It is worth noting that, as much as LPS designs get a good reputation and SMPS designs get a bad reputation, the reality is somewhere in between. And the situation is dynamic.

First, LPS designs are on the whole, good and, on average, are quieter than poorly designed SMPS power supplies (which tend to be more for charging mobile phones and are not optimised for noise). This is why LPS is often perceived as superior to SMPS.



Hybrid and electric cars used to be shunned, yet they are now all the rage. We believe the same is happening for SMPS. These are now more environmentally-friendly and consume far less power. Whereas all SMPS used to be 'noisy', we are one of the few companies who have broken down the SMPS into its constituent parts and fundamentally re-designed it for audiophile use ie super low-noise. The iPOWER is the 'Model 3' of SMPS power supplies.



Nevertheless not everyone has an iPOWER at their disposal. It is therefore important to be able to effectively deal with normal SMPS noise which can be quite severe.

The next section explains which aspects of the AC iPurifier target the different groups of noise and how this compares to the common approach.



Tech Notes

December 2017

AC iPurifier
Parts 1 - 5

Part 3: Active beats Passive.

Passive filtration is the most common approach seen in aftermarket power supply accessories.

However, it is not without its limitations:

- i. It filters only in the very high frequencies in the high MHz region.
- ii. To be effective, the capacitors must be large and this means bulky and costly.

Given these drawbacks, the AC iPurifier had to be different, more thorough and more comprehensive.

The solution for the AC iPurifier is active + passive sections for the most complete purification over the frequency range.

1. Wireless Nullification System – covers the high MHz range
2. Active Noise Cancellation – covers high KHz and low MHz ranges
3. Intelligent Earth – connects to SMPS power supplies to drain mains noise

The chart below illustrates the impact upon noise.

The black line represents normal noise found in a system with no remedy for it. It runs across the frequency range at 0dB as it is not reduced.

The red line represents typical mains accessories that have passive circuitry – these typically start to work at 2 MHz.

The green line represents the AC iPurifier impact by starting at 10k and then reducing noise by -35dB and more all the way up to 100 Mhz! By comparison passive filtration starts much higher in the frequency range at 30 MHz so misses out on filtering two-thirds of the noise.

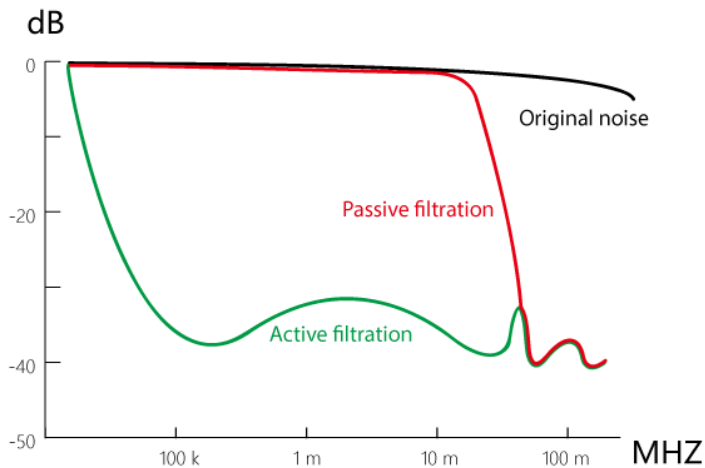

AC iPurifier against generic passive filters

As explained earlier, external sources of noise, from radios to TVs to mobile phones, are not concentrated in just one area as they contribute to noise across the frequency range.

The graph below shows how the AC iPurifier nullifies external noise sources across the frequency spectrum.

By comparison, the generic passive filter does not deal with certain radios and walkie-talkie type products.

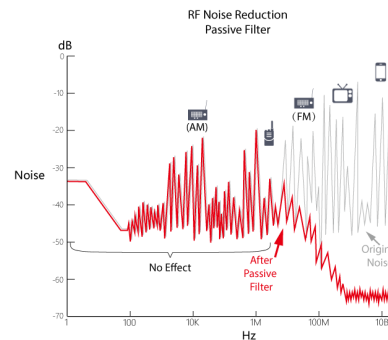
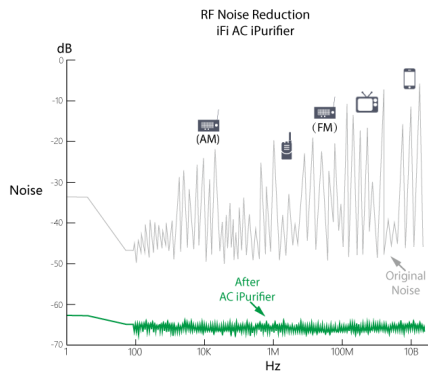

With local sources of noise, these range from linear power supplies (yes they make noise!) to switch-mode power supplies to digital circuitry and all the related harmonics.

It should be no surprise that, with the AC iPurifier actively covering the frequency range, far more noise is reduced – by an impressive -45dB or so!

By comparison, with a generic passive filter, noise from linear power supplies and switched-mode power supplies remain with only some digital circuitry being attended to.



Tech Notes

December 2017

AC iPurifier Parts 1 - 5

Equipment Generated Noise Reduction
iFi AC iPurifier

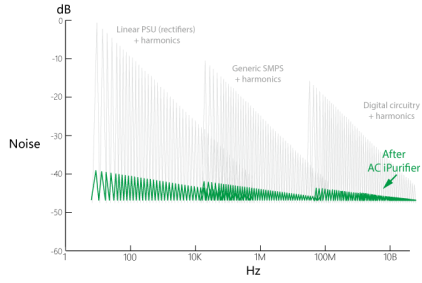

Equipment Generated Noise Reduction
Passive Filter

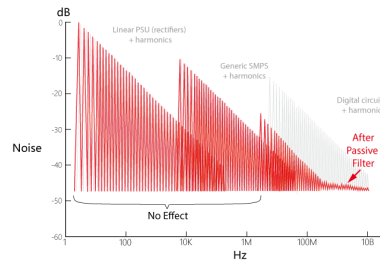

Part 4: Where to deploy.

The AC iPurifier works by taking out noise across the frequency range. In terms of effectiveness, it typically reduces noise by up to 100x or 40dB (and sometimes more).

The following diagram shows the placement of three AC iPurifiers in one system.

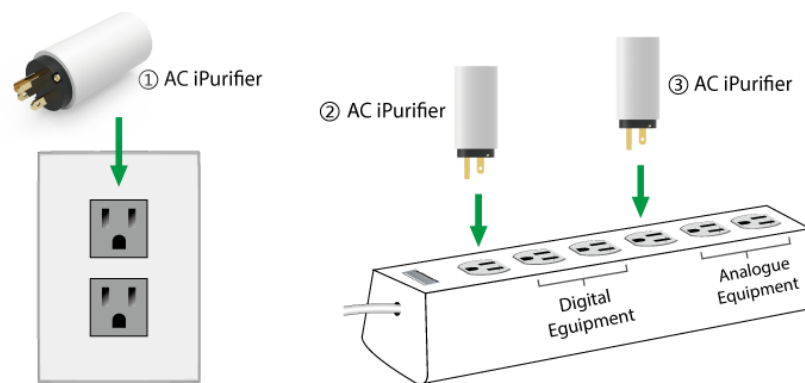

The first AC iPurifier (1) is best inserted into the shared mains wall outlet that supplies the downstream audio system.

A second AC iPurifier (2) should then be situated at the first entry point of the wall mains into the extension block.

A third AC iPurifier (3) is then best located in-between the two types of power supplies. For example we recommend that all linear power supplies are located after the second AC iPurifier but before the third. All SMPS power supplies should then be located after the third AC iPurifier.

By connecting this way, all the respective noise is 'contained' and terminated in its immediate vicinity. Also, the digital and analogue power sources should be in their respective groups as shown in the above diagram.

Part 5: Not just a pretty case.

Not only does the AC iPurifier carry out exceptional noise filtration, it also has several other features to go that extra mile:

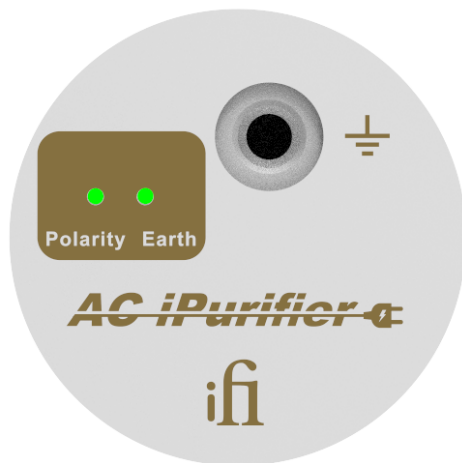

- 1) Smart Diagnostics of Polarity – with both versions, EU and USA, it is possible to connect in the opposite polarity. The AC iPurifier detects a change and indicates this.
- 2) Smart Diagnostics of Earth – detects if the audio mains system it is inserted into has a Ground/Earth or not.
- 3) Intelligent Ground – by attaching the optional ground cable, it is possible to give any system an audio ground. Going directly to the AC iPurifier and into the mains, the Ground/Earth will be of the highest quality connection, making it the most effective at draining system noise.
- 4) Overvoltage Protection System means that electrical shorts, lightning strikes and surges in the mains will be detected and the AC iPurifier itself will instantly shut down to protect downstream components from damage.

To summarise:

The AC iPurifier is no ordinary mains filter.

Firstly, it checks and detects the local mains for Earth and Polarity anomalies.

Secondly, it provides an intelligent Ground/Earth.



Thirdly and most importantly, it purges the audio system mains of noise using both Active and Passive technologies to work across the frequency spectrum, where different types of noise exist.

There is simply no other purifier like it.

For further information, please contact:
Victoria Pickles
press@ifi-audio.com / +44 (0)1704 227 204



About iFi

iFi audio is headquartered in Southport, UK. It is the sister brand of Abbingdon Music Research (AMR). They respectively design and manufacture portable and desktop 'ultra-fidelity' audio products and high-end audio 'home-based' components. The combined in-house hardware and software development team enables iFi audio and AMR to bring to market advanced audio products often ahead of the competition, with several 'world firsts' in their portfolio.